

7WB3306

2-Bit Bus Switch

The 7WB3306 is an advanced high-speed low-power 2-bit bus switch in ultra-small footprints.

Features

- High Speed: $t_{PD} = 0.25$ ns (Max) @ $V_{CC} = 4.5$ V
- 3Ω Switch Connection Between 2 Ports
- Power Down Protection Provided on Inputs
- Zero Bounce
- TTL-Compatible Control Inputs
- Ultra-Small Pb-Free Packages
- These are Pb-Free Devices



ON Semiconductor®

<http://onsemi.com>

MARKING DIAGRAMS



UDFN8
MU SUFFIX
CASE 517AJ

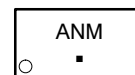

ULLGA8
1.45 x 1.0
CASE 613AA

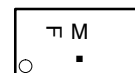

ULLGA8
1.6 x 1.0
CASE 613AB

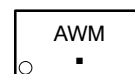

ULLGA8
1.95 x 1.0
CASE 613AC

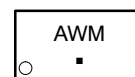

Micro8™
DM SUFFIX
CASE 846A

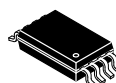
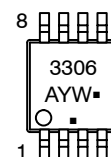

TSSOP8
DT SUFFIX
CASE 948AL

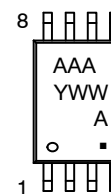

- A = Assembly Location
- Y = Year
- W = Work Week
- M = Date Code
- = Pb-Free Package

(Note: Microdot may be in either location)

ORDERING INFORMATION

See detailed ordering and shipping information in the package dimensions section on page 6 of this data sheet.

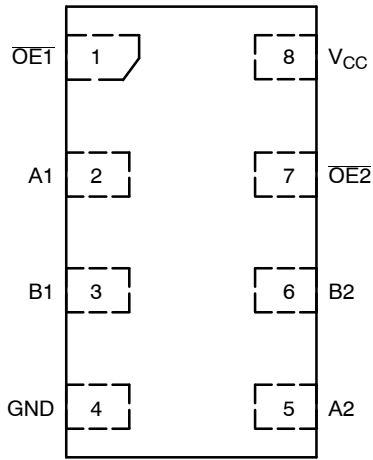

Figure 1. ULLGA8/UDFN8
(Top Thru-View)

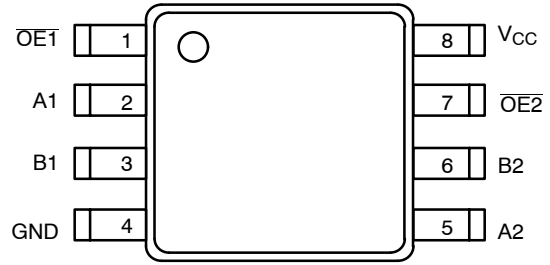

Figure 2. Micro8/TSSOP8
(Top View)

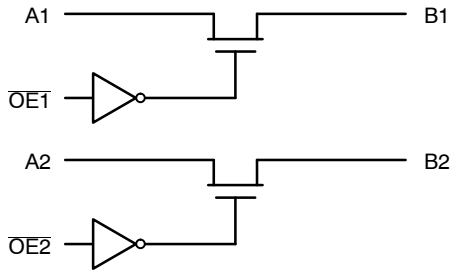

Figure 3. Logic Diagram

FUNCTION TABLE

Input \overline{OE}_n	Function
L	$B_n = A_n$
H	Disconnect

MAXIMUM RATINGS

Symbol	Parameter	Value	Unit
V _{CC}	DC Supply Voltage	-0.5 to +7.0	V
V _{IN}	Control Pin Input Voltage	-0.5 to +7.0	V
V _{I/O}	Switch Input / Output Voltage	-0.5 to +7.0	V
I _{IK}	Control Pin DC Input Diode Current V _{IN} < GND	-50	mA
I _{OK}	Switch I/O Port DC Diode Current V _{I/O} < GND	-50	mA
I _O	ON-State Switch Current	± 128	mA
	Continuous Current Through V _{CC} or GND	± 150	mA
I _{CC}	DC Supply Current Per Supply Pin	± 150	mA
I _{GND}	DC Ground Current per Ground Pin	± 150	mA
T _{STG}	Storage Temperature Range	-65 to +150	°C
T _L	Lead Temperature, 1 mm from Case for 10 Seconds	260	°C
T _J	Junction Temperature Under Bias	150	°C
θ _{JA}	Thermal Resistance UDFN8 (Note 1) ULLGA8 Micro8 TSSOP8	111	°C/W
		455	
		392	
		150	
P _D	Power Dissipation in Still Air at 85°C UDFN8 ULLGA8 Micro8 TSSOP8	1127	mW
		274	
		319	
		833	
MSL	Moisture Sensitivity	Level 1	
F _R	Flammability Rating Oxygen Index: 28 to 34	UL 94 V-0 @ 0.125 in	
V _{ESD}	ESD Withstand Voltage (Note 2) Human Body Model, all pins Human Body Model, A _n /B _n to Ground Human Body Model, A _n /B _n to V _{CC}	> 1.5	kV
		> 4	kV
		> 4	kV
I _{LATCHUP}	Latchup Performance Above V _{CC} and Below GND at 125°C (Note 3)	± 100	mA

Stresses exceeding Maximum Ratings may damage the device. Maximum Ratings are stress ratings only. Functional operation above the Recommended Operating Conditions is not implied. Extended exposure to stresses above the Recommended Operating Conditions may affect device reliability.

1. Measured with minimum pad spacing on an FR4 board, using 10 mm-by-1 inch, 2 ounce copper trace no air flow.
2. Tested to EIA / JESD22-A114-A.
3. Tested to EIA / JESD78.

RECOMMENDED OPERATING CONDITIONS

Symbol	Parameter	Min	Max	Unit
V _{CC}	Positive DC Supply Voltage	4.0	5.5	V
V _{IN}	Control Pin Input Voltage	0	5.5	V
V _{I/O}	Switch Input / Output Voltage	0	5.5	V
T _A	Operating Free-Air Temperature	-55	+125	°C
Δt/ΔV	Input Transition Rise or Fall Rate Control Input Switch I/O	0	5	nS/V
		0	DC	

DC ELECTRICAL CHARACTERISTICS

Symbol	Parameter	Conditions	V _{CC} (V)	T _A = 25°C			T _A = -55°C to +125°C		Unit
				Min	Typ	Max	Min	Max	
V _{IK}	Clamp Diode Voltage	I _{I/O} = -18 mA	4.5			-1.2		-1.2	V
V _{IH}	High-Level Input Voltage (Control)		4.0 to 5.5	2.0			2.0		V
V _{IL}	Low-Level Input Voltage (Control)		4.0 to 5.5			0.8		0.8	V
V _{OH}	Output Voltage High	See Figure 4							
I _{IN}	Input Leakage Current	0 ≤ V _{IN} ≤ 5.5 V	5.5			±0.1		±1.0	μA
I _{OFF}	Power Off Leakage Current	V _{I/O} = 0 to 5.5 V	0			±0.1		±1.0	μA
I _{CC}	Quiescent Supply Current	I _O = 0, V _{IN} = V _{CC} or 0 V	5.5			±0.1		±1.0	μA
ΔI _{CC}	Increase in Supply Current (Control Pin)	One input at 3.4 V; Other inputs at V _{CC} or GND	5.5					2.5	mA
R _{ON}	Switch ON Resistance	V _{I/O} = 0, I _{I/O} = 64 mA I _{I/O} = 30 mA	4.5		3 3	7 7		7 7	Ω
		V _{I/O} = 2.4, I _{I/O} = 15 mA			6	15		15	
		V _{I/O} = 2.4, I _{I/O} = 15 mA	4.0		10	20		20	

AC ELECTRICAL CHARACTERISTICS

Symbol	Parameter	Test Condition	V _{CC} (V)	T _A = 25 °C			T _A = -55°C to +125°C		Unit
				Min	Typ	Max	Min	Max	
t _{PD}	Propagation Delay, Bus to Bus	See Figure 5	4.0 to 5.5			0.25		0.25	ns
t _{EN}	Output Enable Time	See Figure 5	4.5 to 5.5	0.8	2.5	4.2	0.8	4.2	ns
			4.0	0.8	3.0	4.6	0.8	4.6	
t _{DIS}	Output Disable Time		4.5 to 5.5	0.8	3.0	4.8	0.8	4.8	ns
			4.0	0.8	2.9	4.4	0.8	4.4	
C _{IN}	Control Input Capacitance	V _{IN} = 5 or 0 V	5.0		2.5				pF
C _{IO(ON)}	Switch On Capacitance	Switch ON	5.0		10				pF
C _{IO(OFF)}	Switch Off Capacitance	Switch OFF	5.0		5				pF

7WB3306

TYPICAL DC CHARACTERISTICS

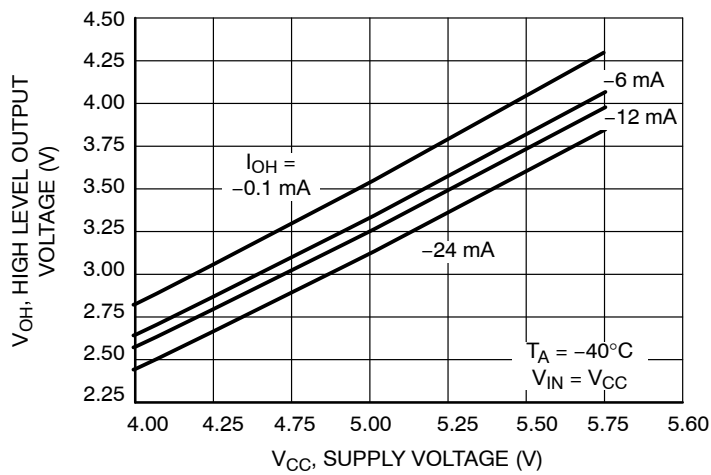
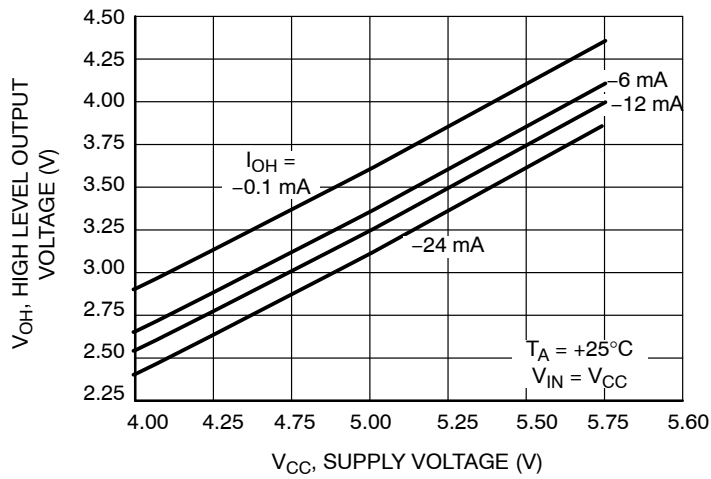
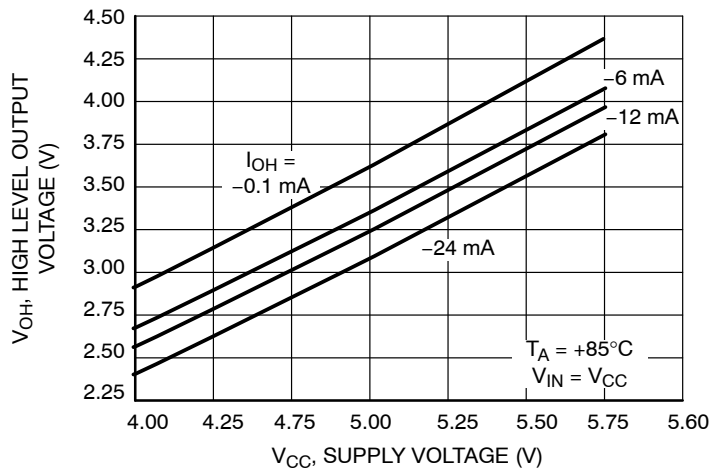
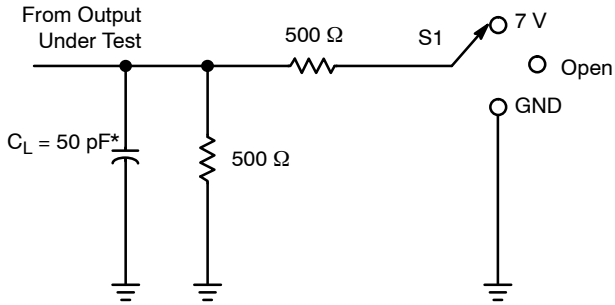

Figure 4. Output Voltage High vs Supply Voltage

AC LOADING AND WAVEFORMS

Parameter Measurement Information



* C_L includes probes and jig capacitance.

Test	S1
t_{PD}	Open
t_{PLZ}/t_{PZL}	7 V
t_{PHZ}/t_{PZH}	Open

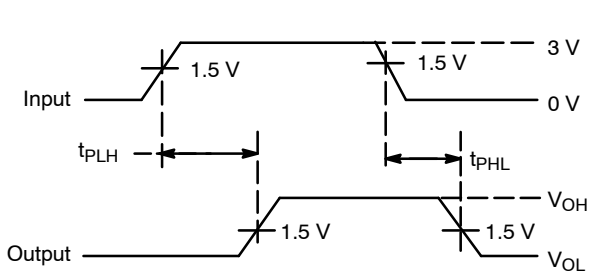

Voltage Waveforms
Propagation Delay Times

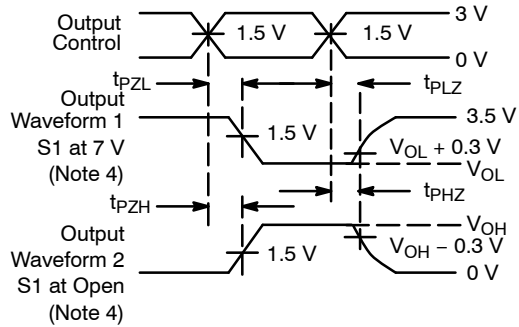

Voltage Waveforms
Enable and Disable Times

- Waveform 1 is for an output with internal conditions such that the output is low, except when disabled by the output control. Waveform 2 is for an output with internal conditions such that the output is high, except when disabled by the output control
- All input pulses are supplied by generators having the following characteristics: $PRR \leq 10 \text{ MHz}$, $Z_O = 50 \Omega$, $t_r \leq 2.5 \text{ ns}$, $t_f \leq 2.5 \text{ ns}$.
- The outputs are measured one at a time, with one transition per measurement.
- t_{PLZ} and t_{PHZ} are the same as t_{DIS} .
- t_{PZL} and t_{PZH} are the same as t_{EN} .
- t_{PHL} and t_{PLH} are the same as t_{PD} .

Figure 5. t_{PD} , t_{EN} , t_{DIS} Loading and Waveforms

ORDERING INFORMATION

Device	Package	Shipping†
7WB3306MUTAG	UDFN8 (Pb-Free)	3000 / Tape & Reel
7WB3306AMX1TCG	ULLGA8 – 0.5 mm Pitch (Pb-Free)	3000 / Tape & Reel
7WB3306BMX1TCG	ULLGA8 – 0.4 mm Pitch (Pb-Free)	3000 / Tape & Reel
7WB3306CMX1TCG	ULLGA8 – 0.35 mm Pitch (Pb-Free)	3000 / Tape & Reel
7WB3306DMR2G	Micro8 (Pb-Free)	4000 / Tape & Reel (In Developmant)
7WB3306DTR2G	TSSOP8 (Pb-Free)	5000 / Tape & Reel

†For information on tape and reel specifications, including part orientation and tape sizes, please refer to our Tape and Reel Packaging Specifications Brochure, BRD8011/D.

7WB3306

PACKAGE DIMENSIONS

UDFN8 1.8 x 1.2, 0.4P
CASE 517AJ-01
ISSUE O

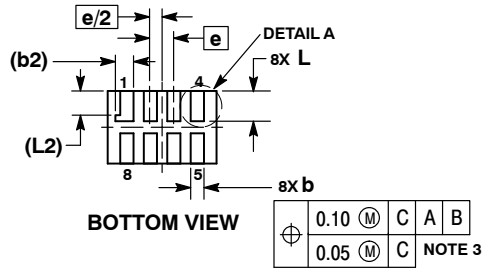
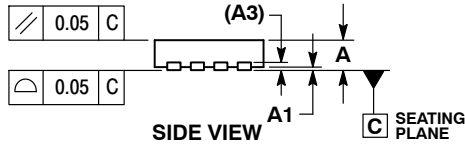
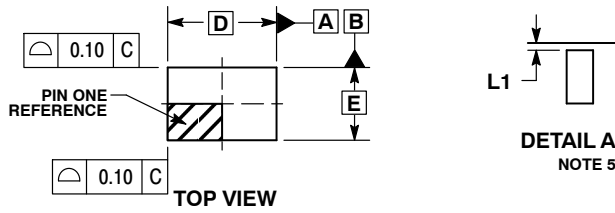

NOTES:

1. DIMENSIONING AND TOLERANCING PER ASME Y14.5M, 1994.
2. CONTROLLING DIMENSION: MILLIMETERS.
3. DIMENSION b APPLIES TO PLATED TERMINAL AND IS MEASURED BETWEEN 0.15 AND 0.30 mm FROM TERMINAL TIP.
4. MOLD FLASH ALLOWED ON TERMINALS ALONG EDGE OF PACKAGE. FLASH MAY NOT EXCEED 0.03 ONTO BOTTOM SURFACE OF TERMINALS.
5. DETAIL A SHOWS OPTIONAL CONSTRUCTION FOR TERMINALS.

MILLIMETERS		
DIM	MIN	MAX
A	0.45	0.55
A1	0.00	0.05
A3	0.127	REF
b	0.15	0.25
b2	0.30	REF
D	1.80	BSC
E	1.20	BSC
e	0.40	BSC
L	0.45	0.55
L1	0.00	0.03
L2	0.40	REF

**MOUNTING FOOTPRINT*
SOLDERMASK DEFINED**

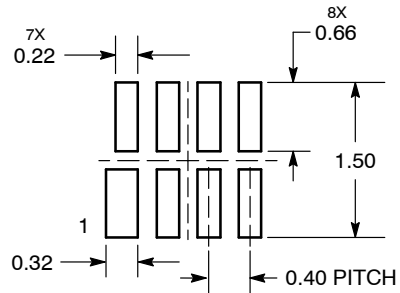

DIMENSIONS: MILLIMETERS

*For additional information on our Pb-Free strategy and soldering details, please download the ON Semiconductor Soldering and Mounting Techniques Reference Manual, SOLDERRM/D.

7WB3306

PACKAGE DIMENSIONS

ULLGA8 1.45x1.0, 0.35P
CASE 613AA-01
ISSUE A

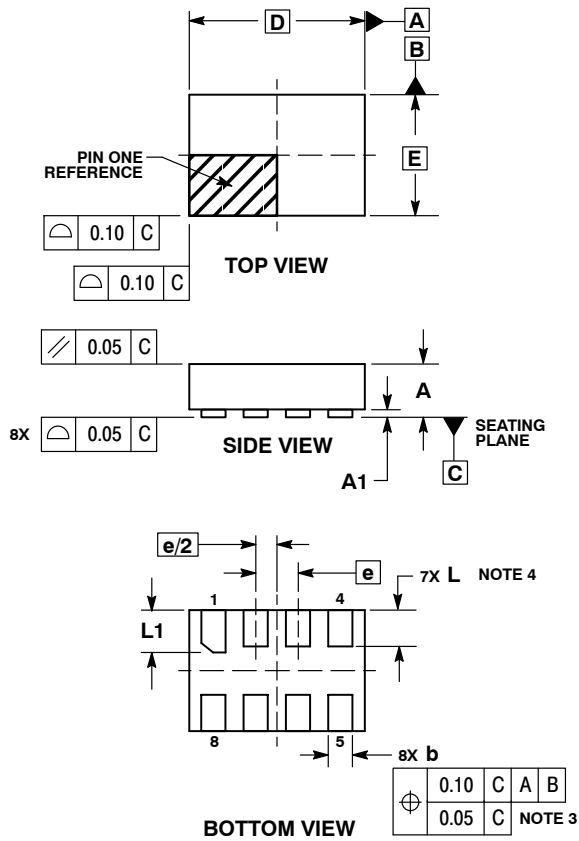

NOTES:

1. DIMENSIONING AND TOLERANCING PER ASME Y14.5M, 1994.
2. CONTROLLING DIMENSION: MILLIMETERS.
3. DIMENSION b APPLIES TO PLATED TERMINAL AND IS MEASURED BETWEEN 0.15 AND 0.30 mm FROM THE TERMINAL TIP.
4. A MAXIMUM OF 0.05 PULL BACK OF THE PLATED TERMINAL FROM THE EDGE OF THE PACKAGE IS ALLOWED.

DIM	MILLIMETERS	
	MIN	MAX
A	---	0.40
A1	0.00	0.05
b	0.15	0.25
D	1.45 BSC	
E	1.00 BSC	
e	0.35 BSC	
L	0.25	0.35
L1	0.30	0.40

**MOUNTING FOOTPRINT
SOLDERMASK DEFINED***

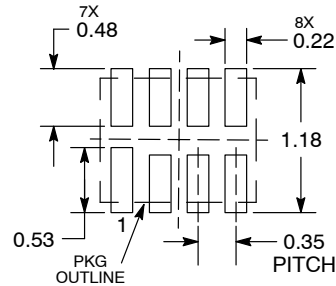

DIMENSIONS: MILLIMETERS

*For additional information on our Pb-Free strategy and soldering details, please download the ON Semiconductor Soldering and Mounting Techniques Reference Manual, SOLDERRM/D.

PACKAGE DIMENSIONS

ULLGA8 1.6x1.0, 0.4P
CASE 613AB-01
ISSUE A

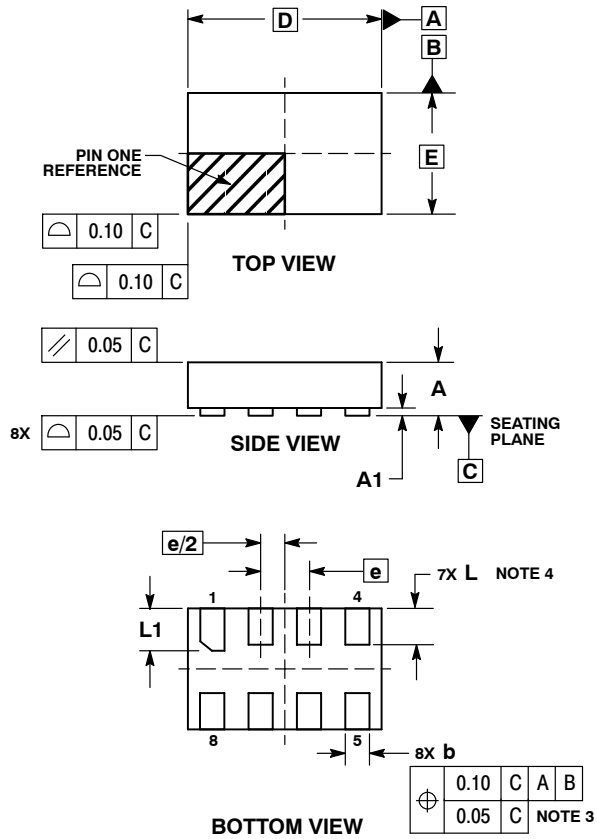

NOTES:

1. DIMENSIONING AND TOLERANCING PER ASME Y14.5M, 1994.
2. CONTROLLING DIMENSION: MILLIMETERS.
3. DIMENSION b APPLIES TO PLATED TERMINAL AND IS MEASURED BETWEEN 0.15 AND 0.30 mm FROM THE TERMINAL TIP.
4. A MAXIMUM OF 0.05 PULL BACK OF THE PLATED TERMINAL FROM THE EDGE OF THE PACKAGE IS ALLOWED.

MILLIMETERS		
DIM	MIN	MAX
A	---	0.40
A1	0.00	0.05
b	0.15	0.25
D	1.60 BSC	
E	1.00 BSC	
e	0.40 BSC	
L	0.25	0.35
L1	0.30	0.40

**MOUNTING FOOTPRINT
SOLDERMASK DEFINED***

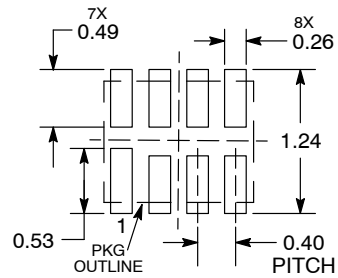

DIMENSIONS: MILLIMETERS

*For additional information on our Pb-Free strategy and soldering details, please download the ON Semiconductor Soldering and Mounting Techniques Reference Manual, SOLDERRM/D.

PACKAGE DIMENSIONS

ULLGA8 1.95x1.0, 0.5P
CASE 613AC-01
ISSUE A

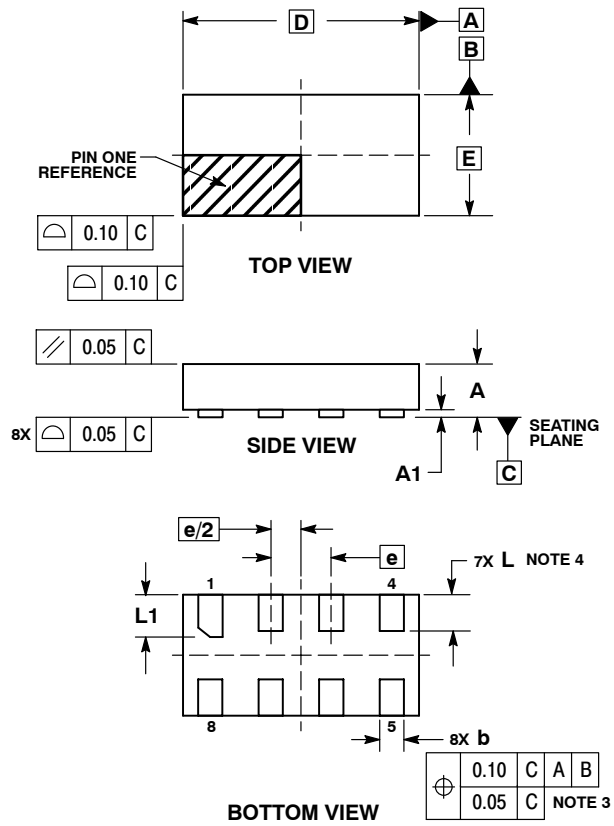

NOTES:

1. DIMENSIONING AND TOLERANCING PER ASME Y14.5M, 1994.
2. CONTROLLING DIMENSION: MILLIMETERS.
3. DIMENSION b APPLIES TO PLATED TERMINAL AND IS MEASURED BETWEEN 0.15 AND 0.30 mm FROM THE TERMINAL TIP.
4. A MAXIMUM OF 0.05 PULL BACK OF THE PLATED TERMINAL FROM THE EDGE OF THE PACKAGE IS ALLOWED.

DIM	MILLIMETERS	
	MIN	MAX
A	---	0.40
A1	0.00	0.05
b	0.15	0.25
D	1.95 BSC	
E	1.00 BSC	
e	0.50 BSC	
L	0.25	0.35
L1	0.30	0.40

**MOUNTING FOOTPRINT
SOLDERMASK DEFINED***

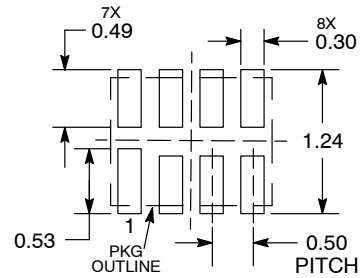

DIMENSIONS: MILLIMETERS

*For additional information on our Pb-Free strategy and soldering details, please download the ON Semiconductor Soldering and Mounting Techniques Reference Manual, SOLDERRM/D.

7WB3306

PACKAGE DIMENSIONS

Micro8™
CASE 846A-02
ISSUE H

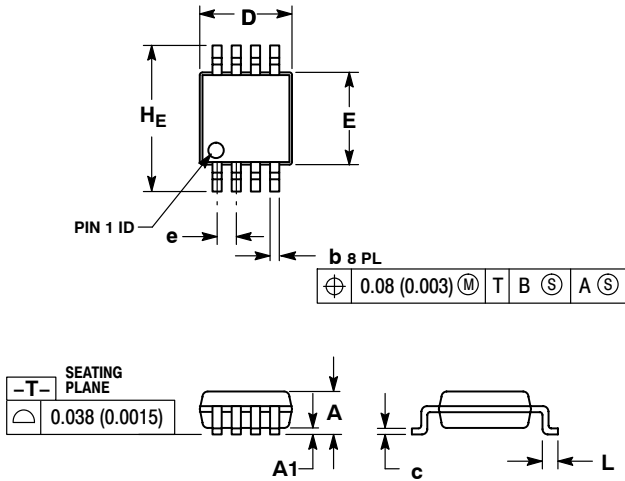

NOTES:

1. DIMENSIONING AND TOLERANCING PER ANSI Y14.5M, 1982.
2. CONTROLLING DIMENSION: MILLIMETER.
3. DIMENSION A DOES NOT INCLUDE MOLD FLASH, PROTRUSIONS OR GATE BURRS. MOLD FLASH, PROTRUSIONS OR GATE BURRS SHALL NOT EXCEED 0.15 (0.006) PER SIDE.
4. DIMENSION B DOES NOT INCLUDE INTERLEAD FLASH OR PROTRUSION. INTERLEAD FLASH OR PROTRUSION SHALL NOT EXCEED 0.25 (0.010) PER SIDE.
5. 846A-01 OBSOLETE, NEW STANDARD 846A-02.

DIM	MILLIMETERS			INCHES		
	MIN	NOM	MAX	MIN	NOM	MAX
A	--	--	1.10	--	--	0.043
A1	0.05	0.08	0.15	0.002	0.003	0.006
b	0.25	0.33	0.40	0.010	0.013	0.016
c	0.13	0.18	0.23	0.005	0.007	0.009
D	2.90	3.00	3.10	0.114	0.118	0.122
E	2.90	3.00	3.10	0.114	0.118	0.122
e	0.65 BSC			0.026 BSC		
L	0.40	0.55	0.70	0.016	0.021	0.028
HE	4.75	4.90	5.05	0.187	0.193	0.199

SOLDERING FOOTPRINT*

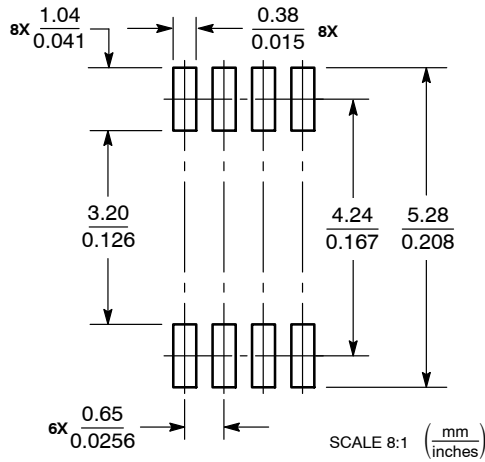

*For additional information on our Pb-Free strategy and soldering details, please download the ON Semiconductor Soldering and Mounting Techniques Reference Manual, SOLDERRM/D.

7WB3306

PACKAGE DIMENSIONS

TSSOP8, 4.4x3
CASE 948AL-01
ISSUE O

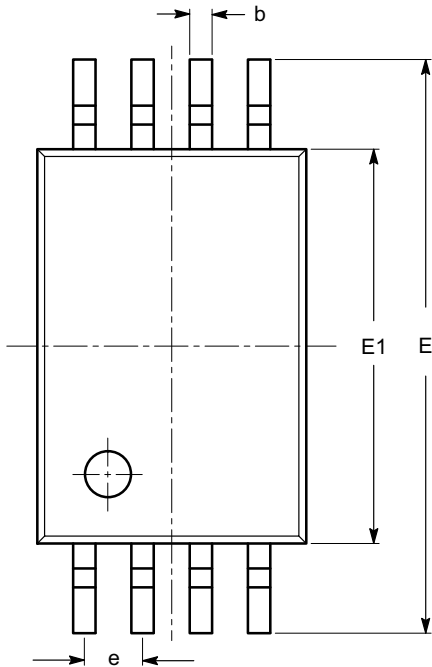

SYMBOL	MIN	NOM	MAX
A			1.20
A1	0.05		0.15
A2	0.80	0.90	1.05
b	0.19		0.30
c	0.09		0.20
D	2.90	3.00	3.10
E	6.30	6.40	6.50
E1	4.30	4.40	4.50
e	0.65 BSC		
L	1.00 REF		
L1	0.50	0.60	0.75
θ	0°		8°

TOP VIEW

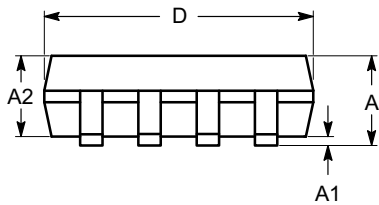

SIDE VIEW

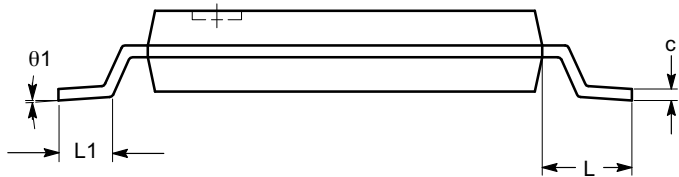

END VIEW

Notes:

- (1) All dimensions are in millimeters. Angles in degrees.
- (2) Complies with JEDEC MO-153.

Micro8 is a trademark of International Rectifier.

ON Semiconductor and  are registered trademarks of Semiconductor Components Industries, LLC (SCILLC). SCILLC reserves the right to make changes without further notice to any products herein. SCILLC makes no warranty, representation or guarantee regarding the suitability of its products for any particular purpose, nor does SCILLC assume any liability arising out of the application or use of any product or circuit, and specifically disclaims any and all liability, including without limitation special, consequential or incidental damages. "Typical" parameters which may be provided in SCILLC data sheets and/or specifications can and do vary in different applications and actual performance may vary over time. All operating parameters, including "Typicals" must be validated for each customer application by customer's technical experts. SCILLC does not convey any license under its patent rights nor the rights of others. SCILLC products are not designed, intended, or authorized for use as components in systems intended for surgical implant into the body, or other applications intended to support or sustain life, or for any other application in which the failure of the SCILLC product could create a situation where personal injury or death may occur. Should Buyer purchase or use SCILLC products for any such unintended or unauthorized application, Buyer shall indemnify and hold SCILLC and its officers, employees, subsidiaries, affiliates, and distributors harmless against all claims, costs, damages, and expenses, and reasonable attorney fees arising out of, directly or indirectly, any claim of personal injury or death associated with such unintended or unauthorized use, even if such claim alleges that SCILLC was negligent regarding the design or manufacture of the part. SCILLC is an Equal Opportunity/Affirmative Action Employer. This literature is subject to all applicable copyright laws and is not for resale in any manner.

PUBLICATION ORDERING INFORMATION

LITERATURE FULFILLMENT:
Literature Distribution Center for ON Semiconductor
P.O. Box 5163, Denver, Colorado 80217 USA
Phone: 303-675-2175 or 800-344-3860 Toll Free USA/Canada
Fax: 303-675-2176 or 800-344-3867 Toll Free USA/Canada
Email: orderlit@onsemi.com

N. American Technical Support: 800-282-9855 Toll Free
USA/Canada
Europe, Middle East and Africa Technical Support:
Phone: 421 33 790 2910
Japan Customer Focus Center
Phone: 81-3-5773-3850

ON Semiconductor Website: www.onsemi.com
Order Literature: <http://www.onsemi.com/orderlit>
For additional information, please contact your local Sales Representative